



MARCUS

Marcus Transformer LTD
 Phone: 1-800-267-7376
 Fax: 1-866-205-7526
 Email: Info@marcustransformer.com

TECHNICAL DATA

SINGLE PHASE CONTROL TRANSFORMER

DESCRIPTION	
MODEL	M98400T
Type	Open
VA	100
Primary (Volts)	208 / 240 / 480 / 600
Secondary (Volts)	24 / 120
Input Amps	0.48 / 0.42 / 0.21 / 0.17
Output Amps	4.17 / 0.83
Temperature Rise	80°C
Insulation Class	B (130°C)
Frequency	60Hz
Polarity	additive
Noise level	less than 40DB
Winding	Copper
Approvals	CE compliant UL listed CSA approved

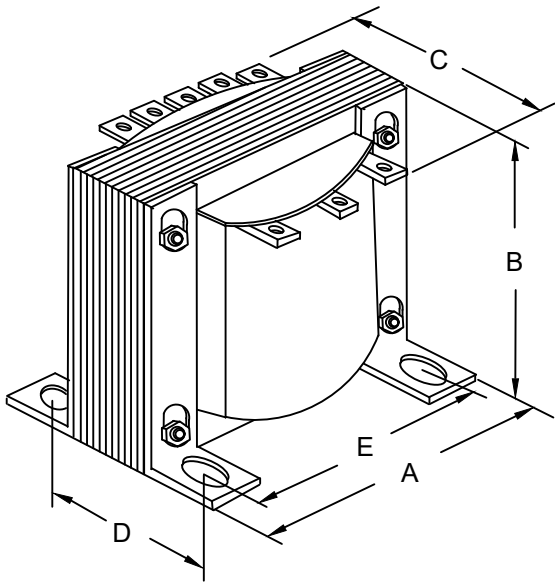
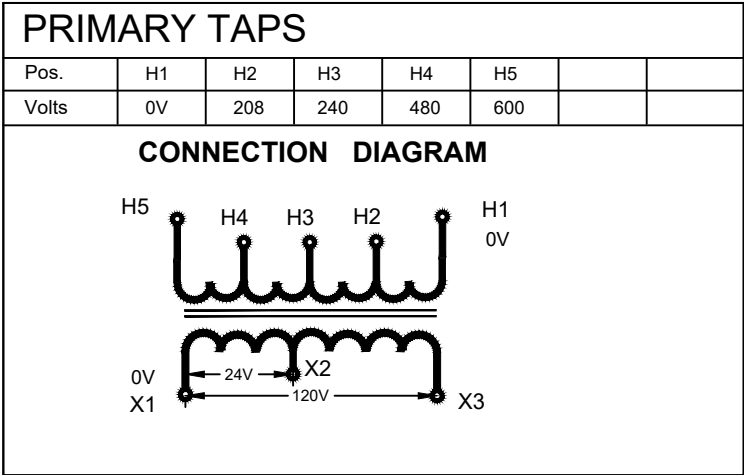

WIRING CONNECTION

PRIMARY :	
VOLTS	CONNECT LINES TO :
208	H1-H2
240	H1-H3
480	H1-H4
600	H1-H5

SECONDARY :	
VOLTS	CONNECT LINES TO :
24	X1-X2
120	X1-X3

DIMENSIONS INCHES / MM

VA	A	B	C	D	E	MOUNTING HOLES INCHES / MM	SHIP WEIGHT LBS / KG
100	3.75 95.3	3.13 79.5	4.02 102.1	3.00 76.2	3.13 79.5	0.21 x 0.625 5.3 x 15.9	5.75 2.6

Notes: